

Journal of Organometallic Chemistry, 186 (1980) 427–445
 © Elsevier Sequoia S.A., Lausanne — Printed in The Netherlands

GROUP IB ORGANOMETALLIC CHEMISTRY

XXXIII *. ArAuPPh₃, ArAu(CNR), (ArAu)_n AND Ar₄Cu₂Au₂ COMPOUNDS IN WHICH THE ARYL GROUP CONTAINS 2-MeO, 2,6-(MeO)₂, 2-Me₂N, 2-Me₂NCH₂ AND (S)- OR (R)-2-Me₂NCHMe SUBSTITUENTS AS POTENTIAL LIGANDS

GERARD VAN KOTEN **,†, CEES A. SCHAAP, JOHANN T.B.H. JASTRZEBSKI and JAN G. NOLTES **

Institute for Organic Chemistry TNO, P.O. Box 5009, 3502 JA Utrecht, (The Netherlands)

(Received August 30th, 1979)

Summary

The synthesis and structural characterization by ¹H NMR and ¹⁹⁷Au Mössbauer spectroscopy as well as by chiral labelling of the built-in ligands of three different types of arylgold(I) compounds is described. ¹⁹⁷Au Mössbauer data revealed that the benzyl- and arylgold(I) triphenylphosphine complexes which bear potential coordinating substituents at an *ortho* position still contain linearly coordinated Au^I with 2c-2e gold(I)—carbon bonds. The observation of isochronous NMe resonances in (S)-2-Me₂NCH(Me)C₆H₄AuPPh₃ confirms that no additional intramolecular Au—N coordination occurs in solution. Preliminary results of an X-ray diffraction study of 2,6-(MeO)₂C₆H₃AuPPh₃ are reported (*R* = 0.040, PAuC₁ angle 172.6°. Unsymmetrical AuC₁C₂ and AuC₁C₆ angles of 126.4 and 117.4°, respectively).

Pure, uncomplexed arylgold(I) compounds have been isolated from the reaction of diarylgoldlithium compounds (arylauroates) with trimethyltin bromide. (S)-2-Me₂NCHMeC₆H₄Au has a dimeric structure which most likely consists of two monomeric units associated by intermolecular Au—N coordination thus forming a ten-membered chelate ring. The structure of insoluble 2-Me₂NCH₂C₆H₄Au and 2-Me₂NC₆H₄Au are less clear. The former compound probably has a structure similar to (S)-2-Me₂NCHMeC₆H₄Au (*IS/QS* values for two-coordinate Au^I centers). However, the strongly deviating *IS* and *QS* values of 2-Me₂NC₆H₄Au indicate that a polynuclear structure for this compound

* For part XXXII, see ref. 1.

** To whom correspondence should be addressed.

† Present address: Anorganisch Chemisch Laboratorium, University of Amsterdam, Nieuwe Achtergracht 166, 1018 WV Amsterdam, The Netherlands.

similar to that proposed for $2\text{-Me}_2\text{NC}_6\text{H}_4\text{Cu}$ cannot be excluded (a polymeric structure containing $2\text{-Me}_2\text{NC}_6\text{H}_4$ groups which span three Au atoms by $3c\text{-}2e$ Au_2C bonds and Au—N coordination).

The mixed Au/Cu cluster $(2\text{-Me}_2\text{NCH}_2\text{C}_6\text{H}_4)_4\text{Au}_2\text{Cu}_2$ is accessible via the $1/2$ reaction of $(2\text{-Me}_2\text{NCH}_2\text{C}_6\text{H}_4)_4\text{Au}_2\text{Li}_2$ with CuI. Molecular weight and ^1H NMR studies point to a tetranuclear structure in solution, while mass spectrometry shows fragment ions with m/e corresponding to $(2\text{-Me}_2\text{NCH}_2\text{C}_6\text{H}_4)_3\text{Au}_2\text{Cu}_2^+$, $(2\text{-Me}_2\text{NCH}_2\text{C}_6\text{H}_4)_3\text{Cu}_2\text{Au}^+$, $(2\text{-Me}_2\text{NCH}_2\text{C}_6\text{H}_4)_2\text{CuAu}_2^+$ and of $(2\text{-Me}_2\text{NCH}_2\text{C}_6\text{H}_4)_2\text{Au}^+$.

Introduction

Introduction of built-in ligands NMe_2 , OMe , PPh_2 , SO_2NMe_2 and CH_2NMe_2 into the organo group in the vicinity of the M—C bond has been shown to be a useful means of stabilization of the metal IB—carbon bond in organometal IB compounds [2]. Thus, a variety of stable aryl [2,3], alkenyl [4] and aryl-ethynyl [5] metal IB compounds (both homo- and hetero-nuclear [6]) has been prepared, for some of which the structure has been established unambiguously by X-ray diffraction. The hydrocarbon-soluble compounds among these have discrete polynuclear structures in which aryl, alkenyl and alkynyl groups are bonded to a central metal core by $3c\text{-}2e$ bonds*.

Complex formation by the built-in ligand with the IB metal is not the only stabilizing factor. Bulkiness of the built-in ligand (e.g. Me_2NCHMe instead of Me_2NCH_2) is an important additional factor [9a,10]. In a recent paper we have presented a rationale for these observations [10]. The observation that the *ortho*-substituted arylmetal IB compounds 2-isopropyl- and 2-isobutyl-phenyl-copper and 8-phenylnaphthylcopper [11], which lack coordinating substituents, display greater thermal stability than phenylcopper illustrates the important influence of steric crowding near the M—C bond [10].

We have extended our study of the nature of the bonding in organocopper compounds [10,12] to arylgold(I) compounds. In this connection the recently reported structural features of some arylgold(I) compounds are relevant. As shown by X-ray analysis the organo-gold(I) complex $\text{CpFeC}_5\text{H}_4(\text{AuPPh}_3)_2^+\text{BF}_4^-$ contains electron-deficient Au—C bonds [7c]. Bridging phenyl groups have been proposed for triphenylgold(I)zinc dimer [14]. In contrast, Vaughan has proposed a trimeric structure with $2c\text{-}2e$ Au—C bonds and intermolecular Au—N coordination for 2-pyridylgold [13].

The coordination behaviour of Cu^{I} and Ag^{I} compounds and that of Au^{I} compounds display some important differences. Cu^{I} and Ag^{I} can either be two-, three- or four-coordinate, whereas Au^{I} prefers to be linearly two-coordinate [15]. In arylcopper and arylsilver compounds lacking intramolecular coordinating substituents the metal atom is two-coordinate by taking part in

* Recently, Nesmeyanov et al. showed that this concept can also be extended to the synthesis of stable ferrocenyl-copper [7a] and -silver compounds [7b]. For example, tetrameric $\text{CpFeC}_5\text{H}_3(\text{CH}_2\text{NMe}_2)\text{M}$ (M = Ag or Cu) appears to have a similar structure to the $2\text{-Me}_2\text{NCH}_2$ -substituted arylcopper compounds for which we reported a crystal structure in 1972 [8].

two *3c-2e* M—C interactions [e.g. (2-MeC₆H₄Cu)₄ [9], polymeric (C₆H₅Cu)_n [2d] and (C₆H₅Ag)_n [16]]. Three-coordination is usually observed if a built-in ligand is present [e.g. (5-Me-2-Me₂NCH₂C₆H₄)₄Cu₄ [8,12a]]. It seems of interest to see whether intramolecular coordination occurs in the corresponding arylgold(I) compounds containing such built-in ligands. Assuming again *3c-2e* bonding for the aryl group this would seem to be less likely in view of the preference of Au^I for two-coordination. This point of view finds support in the structures of (2-Me₂NC₆H₅)₄Au₂M₄X₂ (M = Cu^I or Ag^I; X = halogen or OTf) [6]. In these hexanuclear clusters the two Au atoms occupy the apical positions which have a distinct linear coordination symmetry.

In this paper * we report the synthesis of arylgold(I) compounds containing built-in ligands as well as the results of a structural investigation using ¹H NMR and ¹⁹⁷Au Mössbauer spectroscopy and chiral labelling of the built-in ligand.

Results

The arylgold triphenylphosphine compounds I–V, in which the aryl group bears on one or both *ortho* positions MeO, Me₂N or Me₂NCH₂ groups as built-in ligands, were isolated from the 1/1 reaction of the respective organolithium compounds [2] with bromo(triphenylphosphine)gold(I). The benzylgold complex VI was prepared similarly. The compounds were identified by elemental analyses (C, H, N, Au and P), by NMR spectroscopy (*vide infra*) and by IR spectroscopy. The complexes I–VI exist in benzene as discrete monomeric species (osmometry).



- (I), $n = 0$, R' = 2-Me₂NCH₂
 (II), $n = 0$, R' = (5)-2-Me₂NCHMe
 (III), $n = 0$, R' = 2-Me₂N
 (IV), $n = 0$, R' = 2,6-(MeO)₂
 (V), $n = 0$, R' = 2,4,6-(MeO)₃
 (VI), $n = 1$, R' = 2-Me₂NCH₂

The reactions performed with a 2/1 (ArLi/Au) molar ratio gave the corresponding diarylgoldlithium compounds VII–X and free triphenylphosphine. These compounds were also prepared via the 1/1 reactions of the arylgold triphenylphosphine compounds I–IV with the appropriate aryllithium derivatives [18].

The diarylgoldlithium compounds VII–X (also called arylaurates) are soluble in benzene and slightly soluble in ethers, whereas X is only soluble in strongly coordinating solvents such as pyridine. They have a surprisingly high thermal stability, which is demonstrated by decomposition points as high as 180°C.

* Part of this work was described in preliminary communications [17].

However, the arylgoldlithium compounds are very sensitive towards hydrolysis.

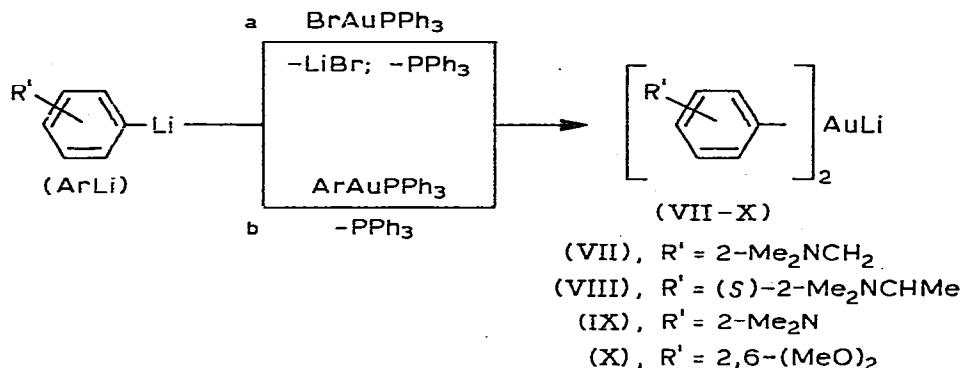

The reaction of $2\text{-Me}_2\text{NCH}_2\text{C}_6\text{H}_4\text{Li}$ tetramer with ClAuAsPh_3 was studied as a possible route for the synthesis of the organogold compounds ArAu bearing exclusively the built-in ligand as a potentially coordinating group. The 1/1 reaction did give free Ph_3As which was isolated quantitatively, and $2\text{-Me}_2\text{NCH}_2\text{C}_6\text{H}_4\text{Au}$ separated from the solution, but could not be purified because of its insolubility.

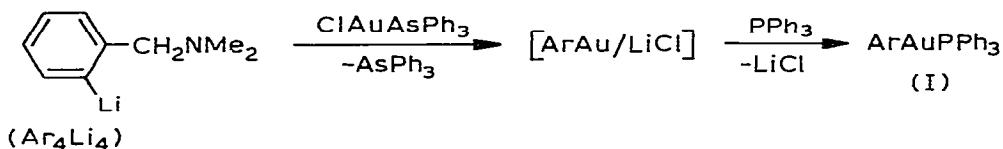

Its formation was established, however, via the interaction of the insoluble solid with triphenylphosphine, which gave the benzene-soluble $2\text{-Me}_2\text{NCH}_2\text{C}_6\text{H}_4\text{AuPPh}_3$ (I). Furthermore, the NMR spectrum of the solid in pyridine- d_5 appeared to be identical to the spectrum obtained for pure $2\text{-Me}_2\text{NCH}_2\text{C}_6\text{H}_4\text{Au}$ (XI) obtained via the route described below.

Pure arylgold compounds, ArAu , lacking coordinated external ligands were prepared via a novel reaction sequence involving the reaction of diarylgold-lithium compounds with trimethyltin bromide or a diorganotin dihalide according to:

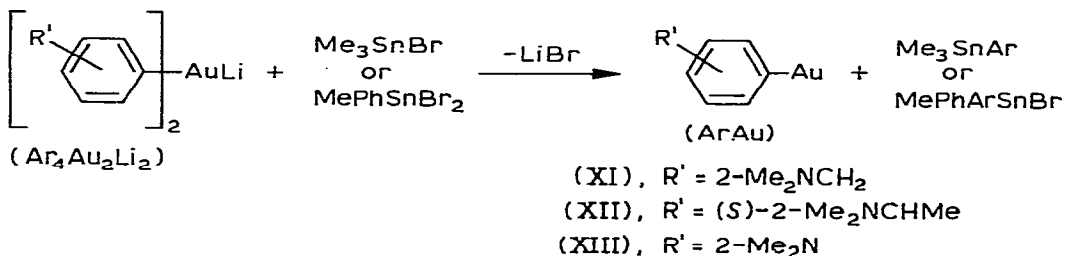

The compounds XI–XIII decompose slowly in air, and decompose upon heating in a N_2 atmosphere at 70°C (XII and XIII) and at 117°C (XI). XI and XIII are insoluble in hydrocarbon solvents, but soluble in pyridine, whereas XII

appeared to be soluble in both pyridine and benzene. XII exists in benzene as a dimer (cryometry).

In the presence of triphenylphosphine, XI–XIII form the corresponding 1/1 complexes ArAuPPh_3 , but no reaction occurs with triphenylarsine (vide supra).

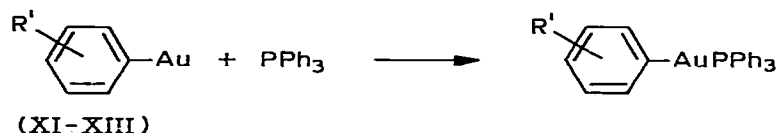

Similarly, XI forms a 1/1 complex with cyclohexyl isocyanide. No reaction occurred upon heating this complex with an excess of the ligand*.

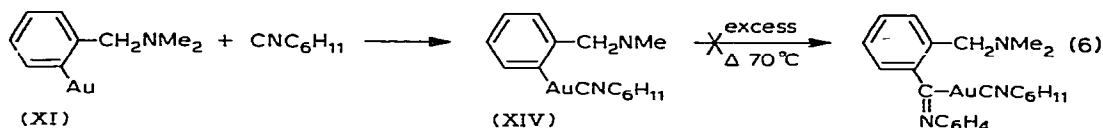

The reaction of $2\text{-Me}_2\text{NC}_6\text{H}_4\text{Au}$ (XI) and of the corresponding $(2\text{-Me}_2\text{NC}_6\text{H}_4)_4\text{Au}_2\text{Li}_2$ (VII) compounds with metal IB salts resulted in the formation of a variety of mixed gold-metal IB cluster compounds of the type $(2\text{-Me}_2\text{NC}_6\text{H}_4)_4\text{Au}_2\text{M}_4\text{X}_2$ ($\text{M} = \text{Cu}$ or Ag ; $\text{X} = \text{Cl}$, Br , or OTf) (see ref. 6). In an analogous reaction, interaction of $(2\text{-Me}_2\text{NCH}_2\text{C}_6\text{H}_4)_4\text{Au}_2\text{Li}_2$ [18] with two equivalents of cuprous iodide in benzene afforded the tetranuclear mixed gold-copper compound XV.

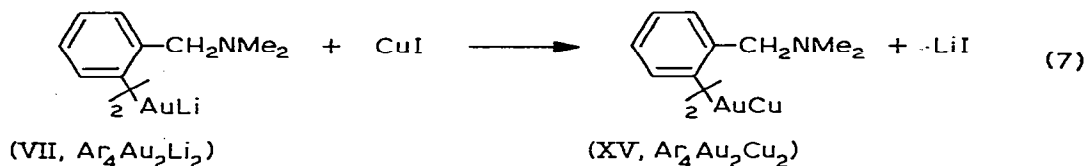

The identity of this compound was confirmed by elemental analysis, molecular weight determinations involving cryoscopy, and mass spectrometry and by NMR spectroscopy (vide infra).

Discussion

The arylgold compounds presented in this paper possess combinations of features which might lead to structures not found before. Three types of compounds are considered: *i*, the ArAuL (I–V, XIV) and ArCH_2AuL (VI) compounds in which the gold atom interacts with one external ligand while additional interaction with one of the internal ligands ($2\text{-Me}_2\text{NCH}_2$, 2-MeO or Me_2N) may occur; *ii*, the ArAu compounds (XI–XIII) which contain exclusively internal ligands as potentially coordinating groups; *iii*, the $\text{Ar}_4\text{Cu}_2\text{Au}_2$

* This behaviour contrasts with that of $(2\text{-Me}_2\text{NCH}_2\text{C}_6\text{H}_4)_4\text{Cu}$ and other arylcopper compounds which readily undergo 1/1 insertion reactions with isocyanides. The use of an excess of isocyanide results in the formation of the 1/1 complex of the 1/1 insertion product and isocyanide [19].

cluster compound (XV) in which the aryl group Ar likewise bears a built-in ligand, but is also part of a polynuclear structure. The structural evidence for each class of compounds as obtained from ^1H NMR, mass spectroscopic and ^{197}Au Mössbauer studies as well as by chiral labelling will be discussed below.

The ArAuL and ArCH_2AuL compounds

The gold atom in these monomeric compounds is at least two-coordinate because it is $2c-2e$ bonded to one aryl group and to the monodentate phosphine or isocyanide. It can become three-coordinate by interaction with the internal ligand. Although the greater part of the Au^{I} compounds have a linear coordination symmetry at the Au^{I} atom [20], the recently reported $\text{ClAu}(\text{PPh}_3)_2$ compounds (cf. X-ray analysis of this compound [21]) contain three-coordinate Au^{I} . Thus, a priori exclusion of a trigonal coordination geometry at the Au^{I} atoms in the compounds $2\text{-Me}_2\text{NCHZC}_6\text{H}_4\text{AuL}$ ($\text{Z} = \text{H, Me}$) is not justified.

The ^1H NMR data for I and XIV which both contain a $2\text{-Me}_2\text{NCH}_2$ substituent are not very conclusive with respect to the occurrence of intramolecular $\text{Au}-\text{N}$ coordination. The chemical shifts for the $2\text{-Me}_2\text{NCH}_2$ protons in $2\text{-Me}_2\text{NCH}_2\text{C}_6\text{H}_4\text{AuL}$ and free $\text{Me}_2\text{NCH}_2\text{C}_6\text{H}_5$ are almost equal (see Table 1). The same invariance of the chemical shift of these protons was observed for $2\text{-Me}_2\text{NCH}_2\text{C}_6\text{H}_4\text{Cu}$ tetramer [12a], monomeric $2\text{-Me}_2\text{NCH}_2\text{C}_6\text{H}_4\text{Cu}$ -diphos and -dppe [22] with respect to free $\text{Me}_2\text{NCH}_2\text{C}_6\text{H}_5$. These observations led us

TABLE 1
 ^1H NMR DATA FOR THE ArAuL COMPLEXES I-VI AND XIV

$\text{ZC}_6\text{H}_4(\text{CH}_2)_n\text{AuL}$			Solvent	δ (ppm) ^a				
Z	n	L		NMe	NCH ₂	OMe	α -Me	Others ^b
2-Me ₂ NCH ₂	0	PPh ₃	CCl ₄	2.10s	3.54s	—	—	—
			C ₆ D ₆	2.28s	3.95s	—	—	8.10m ^c
			C ₅ D ₅ N	2.23s	3.92s	—	—	7.95m ^c
2-Me ₂ NCH ₂ (S)-2-Me ₂ NCHMe	0	CNC ₆ H ₁₁ PPh ₃	C ₆ D ₆	2.35s	4.02s	—	—	2.60br ^{d, e}
			C ₆ D ₅ CD ₃	2.33s	3.95q ^f	—	1.60d ^f	—
2-Me ₂ N	0	PPh ₃	CCl ₄	2.90s	—	—	—	g
			C ₆ D ₆	3.06s	—	—	—	8.10m ^c
			C ₅ D ₅ N	3.08s	—	—	—	7.90m ^c
2,6-(MeO) ₂	0	PPh ₃	CCl ₄	—	—	3.73s	—	h
			C ₆ D ₆	—	—	3.68s	—	h
2,4,6-(MeO) ₃	0	PPh ₃	CCl ₄	—	—	3.70s	—	6.0d ^{j, i}
			C ₆ D ₆	—	—	(3.60s ^k) (3.75s ^l)	—	6.55 ^{i, j}
2-Me ₂ NCH ₂	1	PPh ₃	C ₆ D ₆	2.25	3.97s	—	—	3.30br ^{m, n}
Free Me ₂ NCH ₂ C ₆ H ₅			CCl ₄	2.15s	3.25s	—	—	7.18s
			C ₆ D ₆	2.05s	3.20s	—	—	8.0-7.4m

^a Relative to internal TMS at room temperature. ^b Only multiplets which could be assigned are presented.

^c Multiplet tentatively assigned to H(6). ^d α -H of C₆H₁₁. ^e Multiplet arising from the aryl protons centered at 7.90 (1 H), 7.74 (1 H) and between 7.3 and 7.4 ppm (2 H). ^f $^3J(\text{H}-\text{H})$ 12 Hz. ^g Broad multiplet arising from the aryl protons including H(6) centered at 6.7 ppm. ^h Aromatic protons of Ar: CCl₄[C₆D₆]; 7.2-7.6 (masked by the H_{ortho} resonances of PPh₃) [6.4 and 6.8 ppm]. ⁱ H(3,5); $J_{3,5}$ 2 Hz. ^j Aromatic protons of PPh₃: CCl₄[C₆D₆]; 7.3-7.7 [6.8-6.1 (m and p); 7.4-7.8 (o)]. ^k 4-MeO. ^l 2,6-(MeO)₂. ^m CH₂Au. ⁿ Aromatic protons of PPh₃: 6.8-7.0 (m and p); 7.1-7.7 (o and protons of Ar).

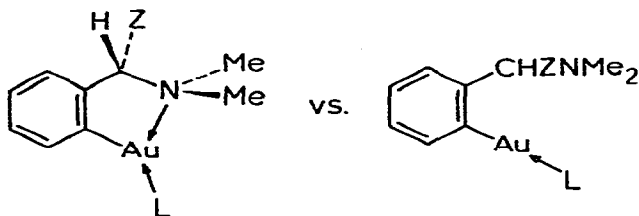

Fig. 1. Possible coordination geometries of Au^I in 2-Me₂NCHZC₆H₄AuPPh₃ (I; Z = H and II; Z = Me).

to the conclusion that the Cu—N interaction in these compounds was absent or very weak. Recently, we have unambiguously established the occurrence of weak Cu—N coordination in the copper tetramer by introduction of a chiral label (i.e. 2-Me₂NCHMe-) in the ortho positions (cf. spectra of (S)-2-Me₂NCHMeC₆H₄Cu tetramer in ref. 10).

Following a similar approach we have prepared (S)-2-Me₂NCHMeC₆H₄AuPPh₃ (II) and studied its dynamic NMR behaviour. The fact that up to -90°C the NMe₂ protons appear as one singlet in the NMR spectrum (see Table 1) indicates that Au—N coordination does not occur* (see Fig. 1). Consequently, in solution the Au^I atom is linearly coordinated.

The structure of these compounds in the solid state was studied by ¹⁹⁷Au Mössbauer spectroscopy. Intramolecular Au—N coordination in I and XIV would result in a five-membered chelate ring with an estimated N—Au—C(1) angle at the Au atom of about 80° (cf. Fig. 1). Such an angle would, however, require the use of gold hybrid orbitals having quite different amounts of *s* and *p* character as compared with the hybrid orbitals used for the bonding in a purely linear L—AuAr complex (cf. Fig. 1). It is well-established that ¹⁹⁷Au Mössbauer spectroscopy is a very sensitive technique for obtaining information concerning such differences [23].

The ¹⁹⁷Au Mössbauer data for 2-Me₂NCH₂C₆H₄AuCNC₆H₁₁ (see Table 2) perfectly fit the plot of *QS* against *IS* for two-coordinate Au^I complexes [23b]. This points to an undisturbed linear coordination at the gold atom, i.e. to the two-coordinate structure in Fig. 1. This conclusion is further supported by the observation of similar *QS* and *IS* values for 2-Me₂NC₆H₄AuPPh₃ (III). The presence of three-coordinate gold in the latter monomeric compound is extremely unlikely, because intramolecular Au—N coordination would imply formation of a sterically unfavourable four-membered chelate ring.

Likewise the occurrence of intramolecular Au—O interaction in 2,6-(MeO)₂C₆H₃AuPPh₃ (IV) seems unlikely. It is noteworthy, however, that preliminary crystallographic data for this compound point to a distorted molecular geometry with unlike Au—O distances of 3.23 and 2.96 Å, respectively, corresponding with Au—C—C angles of 126.4 and 117.4° (see Fig. 2), and a

* Inert Au—N coordination would render the N atom into a stable prochiral center because this blocks pyramidal inversion. As a result of the chirality at the benzylic carbon atom the two Me groups are then diastereotopic and will appear in the ¹H NMR spectrum as two singlets. In the absence of coordination rapid inversion at the N center occurs resulting in homotopic Me groups [10].

TABLE 2

 ^{197}Au MÖSSBAUER DATA FOR SOME ArAuL_n ($n = 0, 1$) AND $\text{Ar}_4\text{Cu}_2\text{Au}_2$ COMPOUNDS ^a

Compound $\text{ZC}_6\text{H}_4\text{Au-L}_n$			IS^b (mm/s)	QS^b (mm/s)
Z	L	n		
2-Me ₂ N	PPh ₃	1	4.84	10.11
2-Me ₂ NCH ₂	CNC ₆ H ₁₁	1	4.62	10.35
2-Me ₂ N	—	—	3.69	6.73
2-Me ₂ NCH ₂	—	—	4.44	7.32
$\text{Ar}_4\text{Cu}_2\text{Au}_2$ Z = 2-Me ₂ NCH ₂			4.42	9.86

^a See also ref. 24 for the Mössbauer fraction *f* data of some of these compounds. ^b Values (± 0.01 mm/s) relative to the source of ^{197}Au in Pt.

C—Au—P angle of 172.6° . Most probably, these features are caused by crystal packing effects rather than by a bonding Au—O interaction.

The ArAu compounds

Based on our earlier finding of a selective arylation of tin halides by aryl-copper derivatives [25–27] we discovered a novel route for the selective formation of arylgold compounds lacking external ligands (cf. eqn. 4).

In these reactions we started from the pure arylgoldlithium compounds which are readily accessible via the reactions shown in eqn. 3. During this reaction the phosphine ligand is released from the gold atom because in the resulting tetranuclear goldlithium species $\text{Ar}_4\text{Au}_2\text{Li}_2$ the gold atom is already two-coordinate by virtue of its involvement in two 3c-2e Au—C bonds * [10,18]. Also in the synthesis of $[(\text{C}_6\text{F}_5)_2\text{Au}]\text{Bu}_4\text{N}$ salt, which represents the only other arylaurate compound reported so far, a ligand L in $\text{C}_6\text{F}_5\text{AuL}$ is replaced by a C_6F_5 group [30].

The synthesis of pure ArAu via eqn. 4 was successful for the 2-Me₂NCH(Z)- (Z = H or Me) or 2-Me₂N-substituted compounds. Moreover, these reactions, which are quantitative, provided us with a unique route to Sn-chiral and C,Sn-chiral triorganotin halides (cf. 26, 27). The course of the reaction, which is still unknown, might involve formation of a Au—Sn intermediate according to:



Aryl transfer from the Ar_2Au^- species to the cationic tin center then completes the reaction **.

* Rice and Tobias have formulated Me_2AuLi as a solvent-separated ion pair $\text{Me}_2\text{Au}^-\text{Li}^+$ [28] in which the coordinatively saturated anion has a linear skeletal structure with two 2c-2e Au—C bonds. In contrast the arylgoldlithium compounds appeared to be polynuclear species in non-coordinating solvents (benzene), e.g. *p*-Tolyl₄Au₄Li₂ · 2 OEt₂ [29], (2-Me₂NCH₂C₆H₄)₄Au₂Li₂ (VII) [10,18], containing 3c-2e bonded aryl groups. However, as a result of the presence of built-in ligands in VII, a structure in the solid comprising gold linearly coordinated by 2c-2e bonded aryl groups, i.e. a structure $\text{Ar-Au}^--\text{Ar}$, cannot be excluded.

** Alternatively, the $\text{Ar}_2\text{AuSnMe}_3$ species can be envisaged to be an $\text{Au}^{\text{III}}-\text{Sn}$ intermediate from which product formation takes place via reductive elimination.

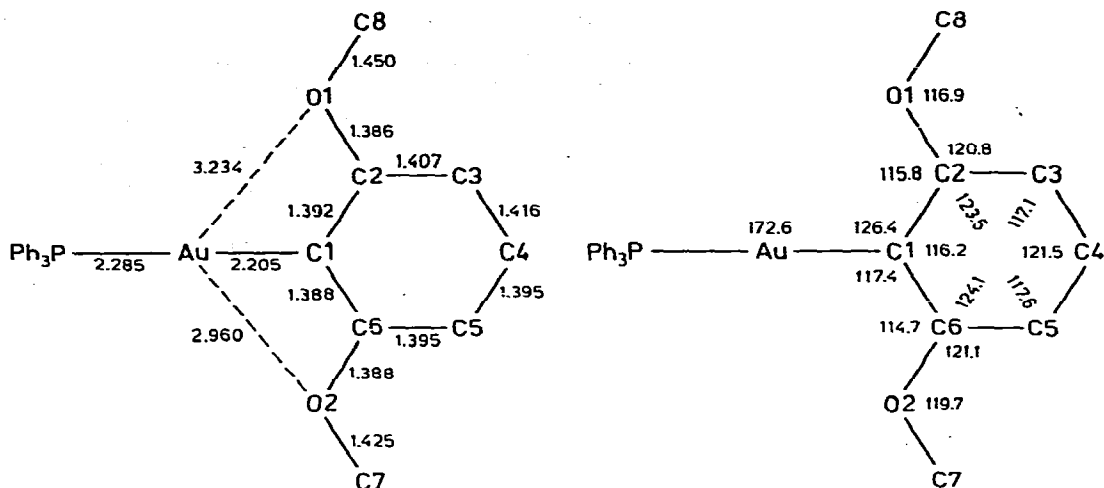

Fig. 2. Bond distances (Å) and angles ($^{\circ}$) in 2,6-(MeO) $_2$ C $_6$ H $_4$ AuPPh $_3$ (IV). $R = 0.040$. Hydrogen atoms were not included in the refinement while the PPh $_3$ phenyl groups were refined as rigid groups. (Private communication by R.E. Davis, University of Texas at Austin, Texas.)

It is noteworthy that the reaction of [2,6-(MeO) $_2$ C $_6$ H $_3$] $_4$ Au $_2$ Li $_2$ with Me $_3$ SnBr proceeds with low selectivity.

Elucidation of the structures of 2-Me $_2$ N(CH $_2$) $_n$ C $_6$ H $_4$ Au ($n = 0$ or 1) by 1 H NMR spectroscopy is difficult, because these compounds are soluble only in coordinating solvents like pyridine. The spectrum of 2-Me $_2$ NC $_6$ H $_4$ Au in pyridine- d_5 is very similar to that of 2-Me $_2$ NC $_6$ H $_4$ AuPPh $_3$ in the same solvent (see Table 1). However, the spectrum of 2-Me $_2$ NCH $_2$ C $_6$ H $_4$ Au (XI) shows two resonance patterns in a 3.5/1 ratio pointing to the presence of two different ArAu species in solution (see Table 3). Addition of PPh $_3$ or CNC $_6$ H $_{11}$ in a 1/1 molar ratio reveals the spectra of the corresponding ArAuL complexes (I) and (XIV). It seems therefore plausible to assume that the major species arises from 2-Me $_2$ NCH $_2$ C $_6$ H $_4$ Au · pyridine whereas the minor component belongs to (ArAu) $_x$ as such.

TABLE 3

1 H NMR DATA FOR THE ArAu COMPLEXES XI–XIII

Compound Z in ZC $_6$ H $_4$ Au	Solvent	δ (ppm) ^a		
		NMe	NCH $_2$	Others
2-Me $_2$ NCH $_2$	C $_5$ D $_5$ N	2.37s ^b (2.71s) ^b	4.08s (4.30s)	7.9, 7.7 and 7.4–7.0 ^c
2-Me $_2$ N	C $_5$ D $_5$ N	3.08	—	7.95m ^d
(S)-2-Me $_2$ NCHMe	Tol- d_8	2.20s ^e 2.50s ^e	—	3.10 (NCH, q) ^f , 2.10 (NCMe), 8.0m ^g , 6.75m ^g

^a Relative to TMS internal, at room temperature. ^b The values between parentheses refer to a second species which is present in a constant molar ratio with respect to the first species. ^c Values at which multiplets arising from the aromatic protons are centered. ^d Integration of the peak areas points to one H, most probable H(6) with J_{ortho} 6 and J_{meta} 1.5 Hz. ^e Two broadened singlets with equal intensity. ^f J 7 Hz. ^g Each belongs to one H (d of d: J_{ortho} 7 and J_{meta} 2 Hz).

NMR spectroscopic study of the related C-chiral compound 2-Me₂NCHMeC₆H₄Au (XII), which is soluble in toluene, offers valuable clues as to the structure of this type of compound. This compound, which is dimeric according to mass spectra (see Experimental), shows a very complex, temperature dependent, NMR pattern below 0°C. The observation of anisochronous NMe resonances points to diastereotopic NMe groups and thus to Au—N coordination which is inert on the NMR time-scale (cf. footnote on p. 433). That only one set of two NMe singlets (and other resonances) is observed is due to the fact that the chiral C center used has the (S) configuration resulting in only the (S),(S) diastereomer. If we assume the presence of electron-precise Au—C bonds (cf. ArAuPPh₃ compounds) then the Au—N coordination is intermolecular (cf. dimeric molecular weight) and we arrive at the structure depicted in Fig. 3A. This structure is similar to the dimeric structure proposed by Issleib for 2-Ph₂PCH₂C₆H₄Au [31].

Similar structures can be envisaged for 2-Me₂NCH₂C₆H₄Au and 2-Me₂NC₆H₄Au (see Fig. 3A, B). However, in the light of their insolubility in non-coordinating solvents these compounds might be polymeric in nature. In particular for 2-Me₂NC₆H₄Au a polynuclear structure involving 3c-2e Au—C bonding analogous to that proposed for (2-Me₂NC₆H₄Cu)_n * [2d] cannot be excluded. In that case (structure C) the gold atoms have the less favored coordination number three instead of two (structure B). The observation that the ¹⁹⁷Au Mössbauer data for XIII fail to fit the least-squares line for two-coordinate Au^I compounds might be considered to support a three-coordinate 2e-3c bonded structure C for XIII. However, it must be noted that in both structures B and C the gold atoms will be in close proximity, resulting in a distortion of the electronic environment of the gold atoms and thus in a deviation of the Mössbauer data from the QS/IS plot.

The difference in solubility of XI (structure A, Z = H) and XII (structure A, Z = Me) is most probably due to the fact that in the latter compound the benzylic carbon center bears a methyl group which is close to the Au₂ unit. For XII a large number of conformations for the ten-membered ring can be envisaged (see Fig. 4; note the position of the (S)-C—methyl groups with respect to the Au atoms). However, the presence in this ring of only four sp³ hybridized atoms will largely restrict this number. Furthermore, depending on the conformation of the ring the (S)-C—Me group is either in-plane or out-of-plane with respect to the aryl nucleus. It has been shown for pentacoordinate 2-Me₂NCHMeC₆H₄SnMePhBr that conformations having this methyl group out-of-plane are slightly more stable [27]. Attempts to analyse the dynamic ¹H NMR pattern on the basis of such considerations failed because of line broadening at temperatures below 0°C as well as the large number of resonances concentrated in a small chemical shift area.

* The proposed structural element [3] in which the 2-Me₂NC₆H₄ group acts as a μ₃ ligand (C—Cu₂ 3c-2e interaction and 2c-2e N—Cu coordination) is based on the structural features of (2-Me₂NC₆H₄)₄Cu₆X₂ (X-ray: X = Br [3] and X = C≡C-p-tolyl [12b]). The general validity of this suggestion for *ortho*-hetero-substituted aryl groups in arylmetal IB chemistry is supported by the structure of 2-anisylcopper octamer [32]. In this structure the 2-MeOC₆H₄ group likewise spans 3 Cu atoms.

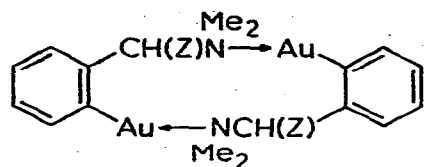

A: XI Z = H; XII Z = Me

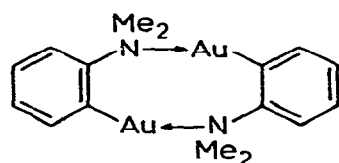

B: XIII based on 2c-2e Au—C bonds

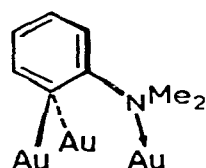

or C: XIII based on 3c-2e Au—C bonds (cf. ref. 2d)

Fig. 3. Possible structures for arylgold compounds having built-in ligands as the only coordinating groups.

The $Ar_4Cu_2Au_2$ compound XIII

Heterometal cluster compounds of the type $Ar'_4Au_2M'_2X_2$ in which M' is Cu or Ag can readily be prepared via the interaction of $Ar'_4Au_2Li_2$ or $Ar'Au$ ($Ar' = 2-Me_2NC_6H_4$) with a $M'X$ salt [6]. These compounds have structures consisting of hexanuclear mixed metal cores, in which the linearly coordinated Au atoms

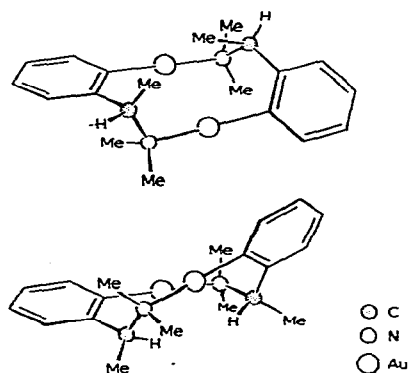

Fig. 4. Conformations of the ten-membered ring showing the positions of the (*S*)-CMe groups with respect to the Au atoms.

occupy apical positions and the aryl groups are 3c-2e bonded bridging one Au and one M' atom. Attempts to synthesize $\text{Ar}'_4\text{Au}_6\text{X}_2$ via reaction of $\text{Ar}'\text{Au}$ with $\text{Ar}'\text{I}^*$, a route which previously was successfully applied for the synthesis of $\text{Ar}'_4\text{Cu}_6\text{I}_2$ [33], failed.

The synthesis and isolation of $(2\text{-Me}_2\text{NCH}_2\text{C}_6\text{H}_4)_4\text{Au}_2\text{Cu}_2$ (XV) represents a second type of a mixed AuCu cluster compound. The dimeric molecular weight of XV in benzene suggests an $\text{Ar}_4\text{Cu}_2\text{Au}_2$ structure analogous to that established for Ar_4Cu_4 by X-ray analysis [12a]. This is supported by the striking similarity of the fragmentation patterns of the Ar_4Cu_4 [12a] and $\text{Ar}_4\text{Au}_2\text{Cu}_2$ compounds. The parent ion $\text{Ar}_4\text{Cu}_2\text{Au}_2^+$ is observed while the next highest m/e value corresponds to $\text{Ar}_3\text{Au}_2\text{Cu}_2^+$ resulting from the cleavage of one Ar group from the parent ion. Further ions of which the composition was established by exact mass measurements are $\text{Ar}_3\text{Cu}_2\text{Au}^+$, $\text{Ar}_2\text{CuAu}_2^+$ and R_2Au^+ .

More information about the structure in the solid was provided by ^{197}Au Mössbauer data of XV, which point to linear coordination at the Au atoms. This excludes Au-N coordination because in a polynuclear Ar_4Cu_4 type structure the gold atoms become already two-coordinate by taking part in two 3c-2e ArAu bonds. Accordingly, the structure shown in Fig. 5 is tentatively proposed.

The ^1H NMR spectra in benzene and in pyridine provide information concerning its structure in solution.

In the absence of intra- or interaggregate exchange C(1) of the bridging aryl groups in the structure shown in Fig. 5 represents a chiral center. As a consequence the benzylic protons are diastereotopic in the case that rotation around the C(1)-C(4) axis is slow or blocked on the NMR timescale (cf. 10). This will give rise to anisochronous resonances for these protons (AB pattern). Moreover, inert M-N coordination will render the methyl-N groups diastereotopic and thus anisochronous. However, this picture becomes more complex when in addition to this dynamic process of aryl rotation [10] interaggregate exchange processes between species $\text{Ar}_4\text{Au}_{4-n}\text{Cu}_n$ also play an important role.

A detailed analysis of the ^1H NMR spectra of $\text{Ar}_4\text{Au}_2\text{Cu}_2$ in benzene is hampered by the limited solubility. However, at room temperature two broadened doublets are observed for the CH_2N protons which coalesce at about 50°C to a broad resonance (see Table 4). In combination with the fact that only one singlet for the NMe protons is observed these observations point to rate-determining aryl rotation in ArAuCu moieties and only weak or no M-N coordination. The fact that various broadened multiplets for H(6) are observed which coalesce to one broad multiplet also at 50°C provides evidence for the occurrence of interaggregate exchange processes (cf. interaggregate exchange upon dissolving $(2\text{-Me}_2\text{NC}_6\text{H}_4)_4\text{Ag}_{6-n}\text{Cu}_n\text{Br}_2$ ($n = 2$ or 4) in benzene [3]).

In pyridine only one resonance pattern is observed, comprising one sharp singlet for the CH_2N protons, one for the NMe protons and one sharp multiplet for H(6) (see Fig. 6). In terms of the rotation process only, this would indicate that upon changing the solvent to pyridine this process is now at the fast

* In this reaction AuI would be generated in situ as a result of the coupling reaction $\text{Ar}'\text{Au} + \text{Ar}'\text{I} \rightarrow \text{Ar}'\text{-Ar}' + \text{AuI}$. In a subsequent reaction of unreacted $\text{Ar}'\text{Au}$ with AuI $\text{Ar}'_4\text{Au}_6\text{I}_2$ might then be formed. It must be noted that pure AuI is inaccessible, which excludes the use of the $\text{Ar}'\text{M}/\text{MI}$ route.

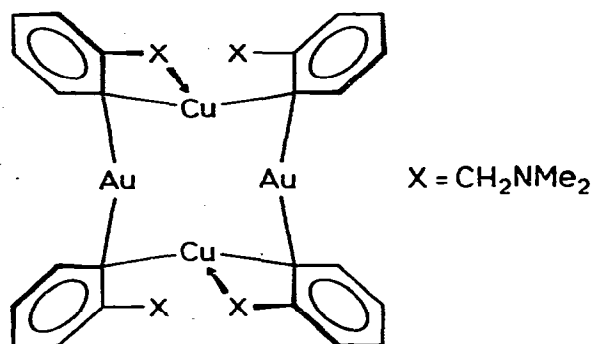

Fig. 5. Proposed structure for $(2\text{-Me}_2\text{NCH}_2\text{C}_6\text{H}_4)_4\text{Au}_2\text{Cu}_2$ (XV).

exchange limit. Since this is very unlikely, a better interpretation might be that in pyridine the interaggregate process is at the fast exchange limit. This is supported by the dynamic ^1H NMR spectra of a 1.2/1 mixture of Ar_4Cu_4 and $\text{Ar}_4\text{Au}_2\text{Cu}_2$ (see Fig. 6).

The H(6) region, which integrates exactly in a 1/2 ratio with the total area of the two CH_2 resonances of Ar_4Cu_4 and $\text{Ar}_4\text{Au}_2\text{Cu}_2$, respectively, contains several multiplets. The spectrum at 115°C shows that the H(6) region coalesces at the position of the H(6) multiplet of pure $\text{Ar}_4\text{Au}_2\text{Cu}_2$ while the two CH_2 singlets and the two NMe singlets start to coalesce. Since the Ar_4Cu_4 cluster structure does not break down in pyridine [22] it seems plausible that also $\text{Ar}_4\text{Au}_2\text{Cu}_2$ is tetranuclear in pyridine. The observation that in benzene the NMe protons appear as a singlet confirms that the Au-N or Cu-N interaction is only weak. It seems likely therefore that the observed dynamic NMR spectra arise from an interaggregate exchange between tetranuclear species. The chemical shifts of the protons in the non-coordinated CH_2NMe_2 ligands is then determined by the set of metals bridged by the aryl group (Cu/Cu, Cu/Au or Au/Au). It is interesting to note that in this case the built-in ligand cannot play a stabilizing role as was observed for $\text{Ar}_4\text{Au}_2\text{Li}_2$ where the *trans*-metal structure was stabilized by Li-N coordination [10,18]. $\text{Ar}_4\text{Au}_2\text{Cu}_2$ differs from Ar_4Cu_4

TABLE 4
 ^1H NMR DATA FOR $(2\text{-Me}_2\text{NCH}_2\text{C}_6\text{H}_4)_4\text{Au}_2\text{Cu}_2$

	δ (ppm) ^a		
	NMe	NCH ₂	Others
$(2\text{-Me}_2\text{NCH}_2\text{C}_6\text{H}_4)_4\text{Au}_2\text{Cu}_2$ ^b in C_6D_6	1.96s	2.34d and 3.87d $J \sim 12$ Hz	$\sim 8.0\text{m}$ H(6)
in $\text{C}_5\text{D}_5\text{N}$	2.29s	3.92s	8.06 H(6) ^c

^a Internal TMS, at room temperature. ^b Accumulated spectra (50 X) on a Varian HA 100 spectrometer using a C-1024 time averaging computer. ^c J_{ortho} 7 Hz and J_{meta} 1.5 Hz.

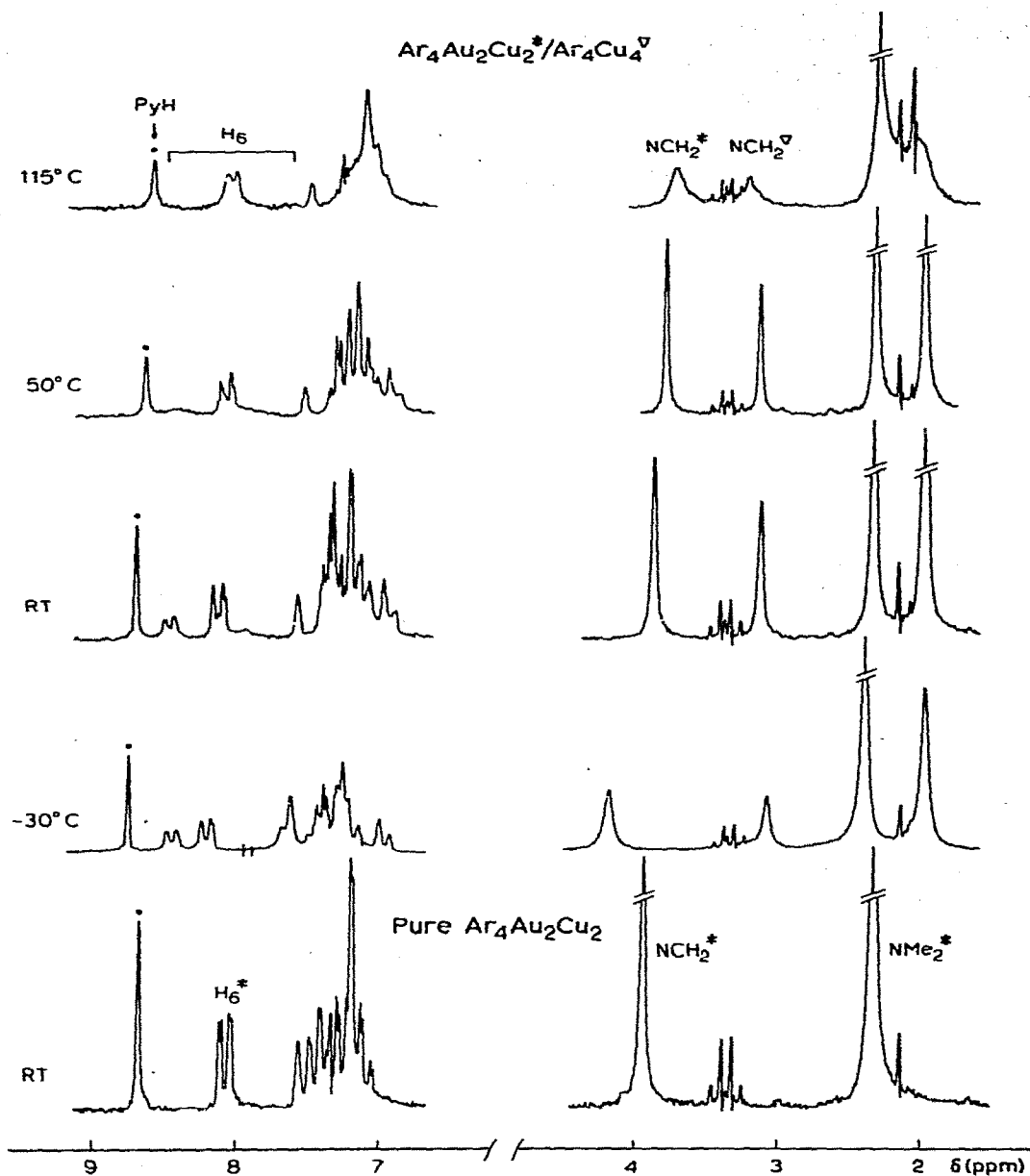
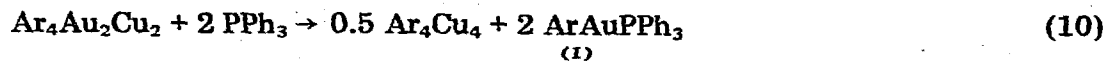

Fig. 6. ^1H NMR spectra (100 MHz; δ ppm) of pure $(2\text{-Me}_2\text{NCH}_2\text{C}_6\text{H}_4)_4\text{Au}_2\text{Cu}_2$ (XV) and of a 1.2/1 mixture of $(2\text{-Me}_2\text{NCH}_2\text{C}_6\text{H}_4)_4\text{Cu}_4$ and $(2\text{-Me}_2\text{NCH}_2\text{C}_6\text{H}_4)_4\text{Au}_2\text{Cu}_2$ in pyridine- d_5 .

in that it readily breaks down in the presence of PPh_3 to give ArAuPPh_3 (I) and Ar_4Cu_4 in an irreversible reaction.



This is undoubtedly connected with the stability of I. Break-down of Ar_4Cu_4 would lead to less stable $\text{Ar}_n\text{Cu}_n/(\text{PPh}_3)_m$ species [22].

Conclusions

The present results are a further illustration of the distinct preference of Au^I for a linear two-coordinate structure. No spectroscopic evidence for the occurrence of Au-N coordination in the 2-Me₂NCH₂C₆H₄AuL complexes which would render the Au atom three-coordinate, was obtained either for the solid state or solutions.

Arylgold(I) compounds, in which the aryl group bears a potentially coordinating group, are now readily available via reaction of the corresponding arylaurates with di- or tri-organotin halides.

The structures of the arylgold(I) compounds lacking external ligands contrast with those of the corresponding aryl-copper and -silver compounds, which are definitely cluster species with 3c-2e bonded aryl groups. The arylgold(I) compounds most probably have structures containing 2c-2e bonded aryl groups, which are associated via intermolecular coordination of the internal ligand with the gold atom. However, the Mössbauer spectra of 2-Me₂NC₆H₄Au indicate that this compound might have a cluster structure similar to that proposed for the corresponding copper compound.

When arylgold compounds are treated with the corresponding copper or silver compounds, heterogold-metal IB cluster structures can be formed which are quite stable. This conclusion is justified by the isolation of (2-Me₂NCH₂C₆H₄)₄Au₂Cu₂ from the reaction of ArAu with ArCu in benzene, while at an earlier stage of our research hexanuclear (2-Me₂NC₆H₄)₆Au₂M₄X₂ species already had been synthesized. It is interesting to note that the architecture of these clusters is such that again the gold atoms represent two-coordinate metal sites in the heterometal IB cores. ¹H NMR spectroscopic data of solutions of pure (2-Me₂NCH₂C₆H₄)₄Au₂Cu₂ reveal that rotation of the 3c-2e bonded 2-Me₂NCH₂C₆H₄ group around the C(1)-C(4) axis takes place. A study of mixtures of the Au₂Cu₂ cluster with (2-Me₂NCH₂C₆H₄)₄Cu₄ showed that interaggregate exchange between these homo and heterometal IB clusters takes place readily.

Experimental

All reactions were carried out under dry oxygen-free nitrogen.

The NMR spectra were recorded using Varian Associates T-60 (¹H), HA-100 (¹H) and XL-100/15 FT (¹³C) NMR spectrometers.

Elemental analyses were carried out in the Analytical Department of the TNO Institute.

The aryllithium compounds were prepared by published methods [2].

Synthesis of {2-[(dimethylamino)methyl]phenyl}(triphenylphosphine)gold(I) (I)

Solid BrAuPPh₃ (5 mmol) was slowly added at -20°C to a suspension of [2-(dimethylamino)methyl]phenyllithium (5 mmol) in ether (50 ml). The mixture was stirred at -20°C for 1 h, for 1½ h at room temperature and then filtered. The filtrate was concentrated to give a white residue, which was extracted with benzene (20 ml). Insoluble LiBr was separated by centrifugation of the suspension and decantation of the benzene solution. Concentration of

the benzene solution gave an almost colourless viscous oil which solidified with difficulty. Repeated dissolution in ether followed by precipitation with pentane finally gave white crystalline (I) in 65% yield. Found: C, 54.5; H, 4.3; N, 2.4; Au, 33.1; P, 5.2. $C_{27}H_{27}NAuP$ calcd.: C, 54.65; H, 4.59; N, 2.36; Au, 33.19; P, 5.22%; Mol.wt. (osmometric in benzene) found (calcd.), 588 (593.5). M.p. 99.5–100°C. NMR data: see Table 1.

II was prepared by a similar method. Recrystallization from hot hexane gave white crystalline (II) in 70% yield. Found: C, 55.1; H, 4.8; N, 2.3; P, 5.0. $C_{28}H_{29}NAuP$ calcd.: C, 55.36; H, 4.81; N, 2.31; P, 5.10%. Mol.wt. (osmometric in benzene) found (calcd.), 588 (607.5). M.p. 129°C (with decomposition). NMR data: see Table 1.

Synthesis of [2-(dimethylamino)phenyl](triphenylphosphine)gold(I) (III)

A solution of 2-(dimethylamino)phenyllithium (5 mmol) in ether (20 ml) was added to a suspension of $BrAuPPh_3$ (5 mmol) in ether (20 ml) at 0°C. Stirring was continued at 0°C for 1 h and at room temperature for 2 h. The white precipitate was filtered off, washed with ether (15 ml) and dried in vacuum. Recrystallization of the solid from petroleum ether (60/80)/benzene (2/1; 180 ml) gave white III in 80% yield. Found: C, 51.9; H, 4.1; N, 1.9; Au, 34.2; P, 5.6. $C_{26}H_{25}NAuP$ calcd.: C, 53.90; H, 4.35; N, 2.42; Au, 33.99; P, 5.35%. Mol.wt. (osmometric in benzene) found (calcd.), 567 (579.4). Dec. 172–174°C (slow colouration starts at 145°C). NMR data: see Table 1.

Synthesis of (2,6-dimethoxyphenyl)(triphenylphosphine)gold(I) (IV)

Solid $BrAuPPh_3$ (5 mmol) was added at –20°C to a solution of 2,6-dimethoxyphenyllithium. The resulting white suspension was stirred at –20°C for 1 h, at room temperature for 1½ h and then filtered. The precipitate was extracted with ether (3 × 15 ml; removal of LiBr) and then dried in vacuum. Recrystallization from benzene afforded pure IV in 90% yield. Found: C, 50.6; H, 4.1; Au, 33.4; P, 5.3. $C_{26}H_{24}O_2AuP$ calcd.: C, 52.36; H, 4.06; Au, 33.03; P, 5.19%. Mol.wt. (osmometric in benzene) found (calcd.), 595 (596.4). M.p. 177–178°C (with decomposition). NMR data: see Table 1.

Synthesis of (2,4,6-trimethoxyphenyl)(triphenylphosphine)gold(I) (V)

V was prepared as described above for IV. Yield 60%. Recrystallized from benzene/pentane. Found: C, 49.6; H, 4.2; P, 4.9. $C_{27}H_{26}O_3AuP$ calcd.: C, 51.77; H, 4.18; P, 4.94%. Mol.wt. (osmometric in benzene) found (calcd.), 650 (626.4). M.p. (decomposition) 148–150°C. NMR data: see Table 1.

Synthesis of {2-[(dimethylamino)methyl]benzyl}(triphenylphosphine)gold(I) (VI)

Solid $BrAuPPh_3$ (2 mmol) was added to a solution of 2-[(dimethylamino)-methyl]benzyl lithium (2 mmol) in ether (20 ml). The mixture was stirred for 4 h then filtered, and the filtrate was concentrated. The white residue was extracted with benzene (20 ml; LiBr removed by centrifugation). The benzene extract was concentrated to 5 ml and pentane added, to give white crystalline VI in 65% yield. Found: C, 54.6; H, 5.3; N, 2.2; P, 4.9. $C_{28}H_{29}NAuP$ calcd.: C, 55.36; H, 4.81; N, 2.31; P, 5.10%. NMR data: see Table 1.

Synthesis of 2-[(dimethylamino)methyl]phenylgold(I) (XI)

Via ArLi/ClAuAsPh₃. Solid ClAuAsPh₃ (5 mmol) was added at -20°C to a suspension of 2-[(dimethylamino)methyl]phenyllithium (5 mmol) in ether (50 ml). The mixture was stirred at -20°C for 1 h then for $1\frac{1}{2}$ h at room temperature, and then filtered. The precipitate was extracted with benzene and ether affording a cream-coloured solid which is soluble in pyridine but not in hydrocarbons and ether. The ^1H NMR spectrum in pyridine-*d*₅ pointed to the presence of XI (see below). Addition of triphenylphosphine to a suspension of XI in benzene afforded pure I (correct analyses; ^1H NMR spectrum in C₆D₆ identical to that of I). The yield of I pointed to a 1/1 ArAu/LiCl composition of the solid.

Via Ar₂AuLi/Me₃SnBr. A solution of trimethyltin bromide (5.30 mmol) in benzene (10 ml) was added to a solution of bis{2-[(dimethylamino)methyl]phenyl}goldlithium (5.3 mmol) [18] in benzene (25 ml). A white precipitate was formed, and was filtered off. The filtrate was concentrated to give white trimethyl[2-(dimethylamino)methyl]phenyltin [NMR, $\delta(\text{MeSn}-\text{CH})$ 52 Hz), $\delta(\text{MeN})$ 1.98, $\delta(\text{CH}_2\text{N})$ 3.30 ppm] in quantitative yield. The white precipitate was washed with benzene (2 \times 10 ml) and with ether (3 \times 10 ml) and appeared to be pure XI. Yield 95%. Dec. 117°C . Found: C, 32.0; H, 3.9; N, 4.1; Au, 57.5. C₉H₁₂NAu calcd.: C, 32.64; H, 3.65; N, 4.23; Au, 59.48%. NMR data: see Table 3.

Reaction of XI with triphenylphosphine gave I in quantitative yield.

No reaction of XI with triphenylarsine in benzene occurred. (NMR in benzene-*d*₆ identical to spectrum of free triphenylarsine; NMR in C₅D₅N of the precipitate identical to spectrum of XI.)

Reaction of XI with excess cyclohexylisocyanide in benzene gave a white solid which was isolated by filtration. Recrystallization was from benzene/pentane. Found: C, 43.2; H, 5.3; N, 6.4; Au, 45.0. C₁₆H₂₃N₂Au calcd.: C, 43.64; H, 5.26; N, 6.36; Au, 44.73%. NMR in C₆D₆ identical to that of pure XIV (see Table 1). IR (Nujol; cm⁻¹) $\nu(\text{C}=\text{N})$ 2212 and mol.wt. (osmometric in benzene) found (calcd.) 449 (440) pointed to pure 2-[(dimethylamino)methyl]phenyl (cyclohexylisocyanide)gold(I). M.p. $79-81^{\circ}\text{C}$.

Synthesis of [1-(S)-(dimethylamino)ethyl]phenylgold(I) (XII)

A solution of Me₃SnBr (2.39 mmol) in ether was slowly added to a suspension of VIII (2.39 mmol) in ether (50 ml). From the initially formed solution white XII precipitated slowly, and was filtered off and washed with ether (2 \times 25 ml) then with pentane (2 \times 25 ml). Yield 63%. Upon heating in N₂ slow decomposition of the compound starts at 70°C ($10^{\circ}\text{C}/\text{min}$). Mol.wt. (cryoscopic in benzene) found (calcd. for the dimer), 688 (686). Mass spectrum (70 eV) *m/e*: 686 (*M*⁺). NMR data: see Table 3.

Synthesis of [2-(dimethylamino)phenyl]gold(I) (XIII)

A solution of 5.6 mmol of trimethyltin bromide in benzene (25 ml) was added to a solution of IX (5.6 mmol) in benzene (100 ml). The mixture was stirred for $\frac{1}{2}$ h, after which the light-yellow precipitate was filtered off and washed with ether (2 \times 30 ml: removal of LiBr and Me₃SnAr [NMR, δ MeSn 0.50 ppm ($J(\text{Sn}-\text{CH})$ 54 Hz) and δ MeN 2.50 ppm [25] and then with

pentane (2 × 50 ml). Yield 65%. Found: C, 29.5; H, 3.3; N, 4.0; Au, 59.6. $C_8H_{10}NAu$ calcd.: C, 30.30; H, 3.18; N, 4.42; Au, 62.11%. Dec. (under N_2) 50–55°C. Caution: The compound explodes upon heating in air at about 70°C.

No reaction occurs with 2-iodo-*N,N*-dimethylaniline. With PPh_3 , complex III is formed quantitatively.

Synthesis of tetrakis {2-[(dimethylamino)methyl]phenyl}digolddicopper (XV)

A mixture of VII (2.75 mmol) and cuprous iodide (2.75 mmol) in ether (40 ml) was stirred for 2 h. A yellow solid precipitated, and this was filtered off, washed with ether (2 × 40 ml), pentane (2 × 10 ml) and dried in vacuum. Yellow XV was isolated in 75% yield. Found: C, 40.5; H, 4.6; N, 5.3; Cu, 11.6; Au, 35.2. $C_{18}H_{24}N_2CuAu$ calcd.: C, 40.88; H, 4.57; N, 5.30; Cu, 12.01; Au, 37.24%. Mol.wt. (ebullioscopic in benzene) found (calcd.), 949 (1057.8). Mass spectra (70 eV) exact *m/e* found ($\Delta m/e = \text{found } m/e - \text{calcd. } m/e$): 922.0798 (–34: $(2-Me_2NCH_2C_6H_4)_3Au_2Cu_2^+$), 725.1167 (0: $(2-Me_2NCH_2C_6H_4)_3Cu_2Au^+$), 725.0566 (0: $(2-Me_2NCH_2C_6H_4)_2CuAu_2^+$), 465.1624 (+19: $(2-Me_2NCH_2C_6H_4)_2Au^+$).

Acknowledgements

The authors are indebted to Dr. T.P.A. Vieggers and Dr. J.M. Trooster (University of Nijmegen) for recording the ^{197}Au Mössbauer spectra and helpful discussions. Prof. R.E. Davis (University of Texas at Austin) is thanked for providing the preliminary X-ray data for 2,6-(MeO) $_2C_6H_3AuPPh_3$.

References

- 1 G. van Koten, J.T.B.H. Jastrzebski and J.G. Noltes, *J. Organometal. Chem.*, 177 (1979) 283.
- 2 (a) G. van Koten, A.J. Leusink and J.G. Noltes, *Inorg. Nucl. Chem. Lett.*, 7 (1971) 227; (b) *J. Organometal. Chem.*, 56 (1973) 379; (c) *ibid.*, 84 (1975) 117; (d) *ibid.*, 85 (1975) 105.
- 3 G. van Koten and J.G. Noltes, *J. Organometal. Chem.*, 102 (1975) 551.
- 4 R.W.M. ten Hoedt, G. van Koten and J.G. Noltes, *J. Organometal. Chem.*, 161 (1978) C13; *ibid.*, 179 (1979) 227.
- 5 G. van Koten and J.G. Noltes, *J. Chem. Soc. Chem. Commun.* (1974) 575; R.W.M. ten Hoedt, G. van Koten and J.G. Noltes, *J. Organometal. Chem.*, 133 (1977) 113.
- 6 G. van Koten, J.T.B.H. Jastrzebski and J.G. Noltes, *Inorg. Chem.*, 16 (1977) 1782.
- 7 (a) A.N. Nesmeyanov, Yu.T. Struchkov, N.N. Sedova, V.G. Andrianov, Yu.V. Volgin and V.A. Sazonova, *J. Organometal. Chem.*, 137 (1977) 217; (b) *ibid.*, 153 (1978) 115; (c) A.N. Nesmeyanov, E.G. Perevalova, K.I. Grandberg, D.A. Lemenovskii, T.V. Bankov and O.B. Afanassova, *J. Organometal. Chem.*, 65 (1974) 131.
- 8 J.M. Guss, R. Mason, I. Sotofte, G. van Koten and J.G. Noltes, *J. Chem. Soc. Chem. Commun.*, (1972) 446.
- 9 (a) G. van Koten, J.T.B.H. Jastrzebski and J.G. Noltes, *J. Org. Chem.*, 42 (1977) 2047; (b) H.K. Hofstee, J. Boersma and G.J.M. van der Kerk, *J. Organometal. Chem.*, 144 (1978) 255.
- 10 G. van Koten and J.G. Noltes, *J. Amer. Chem. Soc.*, 101 (1979) 6593.
- 11 Unpublished results.
- 12 (a) G. van Koten and J.G. Noltes, *J. Organometal. Chem.*, 84 (1975) 129; (b) R.W.M. ten Hoedt, J.G. Noltes, G. van Koten and A.L. Spek, *J. Chem. Soc. Dalton*, (1978) 1800.
- 13 L.G. Vaughan, *J. Amer. Chem. Soc.*, 92 (1970) 730.
- 14 P.W.J. de Graaf, J. Boersma and G.J.M. van der Kerk, *J. Organometal. Chem.*, 127 (1977) 391.
- 15 F.A. Cotton and G. Wilkinson, *Advanced Inorganic Chemistry*, 3rd ed, Interscience, London, 1972, p. 1053.
- 16 H.K. Hofstee, J. Boersma and G.J.M. van der Kerk, *J. Organometal. Chem.*, 168 (1979) 241.
- 17 G. van Koten and J.G. Noltes, *J. Organometal. Chem.*, 80 (1974) C56; 82 (1974) C53.
- 18 G. van Koten and J.G. Noltes, *J. Organometal. Chem.*, 174 (1979) 367.

- 19 G. van Koten and J.G. Noltes, *J. Chem. Soc. Chem. Commun.*, (1972) 59.
- 20 H. Schmidbaur, *Angew. Chem.*, 88 (1976) 830; R. Uson, A. Laguna and J. Vicente, *Synth. React. Inorg. Met. Org. Chem.*, 7 (1977) 463.
- 21 N.C. Baenziger, K.M. Dittmore and J.R. Doyle, *Inorg. Chem.*, 13 (1974) 805.
- 22 G. van Koten, J.G. Noltes and A.L. Spek, *J. Organometal. Chem.*, 159 (1978) 441.
- 23 (a) Cf.; C.A. McAuliffe, R.V. Parish and P.D. Randall, *J. Chem. Soc. Dalton*, (1977) 1426; (b) F.A. Vollenbroek, P.C.P. Bouten, J.M. Trooster, J.P. van den Berg and J.J. Bour, *Inorg. Chem.*, 17 (1978) 1345.
- 24 T.P.A. Viegiers, J.M. Trooster, P. Bouter and T.P. Rit, *J. Chem. Soc. Dalton*, (1977) 2074.
- 25 G. van Koten, C.A. Schaap and J.G. Noltes, *J. Organometal. Chem.*, 99 (1975) 157.
- 26 G. van Koten and J.G. Noltes, *J. Amer. Chem. Soc.*, 98 (1976) 5393; *Adv. Chem. Ser.*, 157 (1976) 275.
- 27 G. van Koten, J.T.B.H. Jastrzebski, J.G. Noltes, W.M.G.F. Pontenagel, J. Kroon and A.L. Spek, *J. Amer. Chem. Soc.*, 100 (1978) 5021.
- 28 G.W. Rice and R.S. Tobias, *Inorg. Chem.*, 14 (1975) 2402; 15 (1976) 489.
- 29 G. van Koten, J.T.B.H. Jastrzebski and J.G. Noltes, *J. Organometal. Chem.*, 140 (1977) C23.
- 30 R. Uson, A. Laguna and J. Vicente, *J. Organometal. Chem.*, 131 (1977) 471.
- 31 H.-P. Abicht and K. Issleib, *J. Organometal. Chem.*, 149 (1978) 209.
- 32 A. Camus, N. Marsich, G. Nardin and L. Randaccio, *J. Organometal. Chem.*, 174 (1979) 121.
- 33 G. van Koten, J.T.B.H. Jastrzebski and J.G. Noltes, *Tetrahedron Lett.*, (1976) 223, footnote 15.